



EU

Xcomfort CDAU-01/02, CDAU-01/03

MOELLER



Montageanweisung
 Assembly instructions
 Instructions de montage
 Montážní návod
 Montážny návod
 Montagevejledning
 Instrucciones de montaje
 Szerelési utasítás
 Istruzioni di montaggio
 Montasje anvisning
 Montage instructie
 Instruções de montagem
 Instrukcja montażu
 Montageanvisning
 Asennusohjeet
 Montaj talimatı
 Instrucțiuni de montaj
 Инструкция по монтажу
 οδηγία συναρμολόγησης
 装配说明
 تعليمات التركيب



Lebensgefahr
 Danger
 Danger de mort
 Nebezpečí
 Nebezpečnostvo
 Fare
 Peligro
 Életveszély
 Pericolo di morte
 Fare
 Levensgevaar
 Perigo
 Niebezpieczeństwo
 Varning
 Vaara
 Hayati Tehlike
 Pericol
 Опасность
 κίνδυνος θανάτου
 危險
 خطر على الحياة



Montage nur durch Elektrofachkräfte
 Installation by electricians only
 Montage uniquement par un électricien
 Montáž pouze osobami s elektrotechnickou kvalifikací
 Montáž iba osobami s elektrotechnickou kvalifikáciou
 Må kun installeres af en aut. el-installatør
 Debe ser instalado por un profesional eléctrico
 Csak szakképzett személy szerelheti
 Montaggio esclusivamente ad opera di personale specializzato
 Må monteres av autorisert installatør Gr.L
 Montage alleen door elektromonteurs
 Deve ser instalado por um profissional
 Montaz tylko przez uprawnionych instalatorów
 Får endast utföras av behörig elektriker
 Asennus vain sähköasentajan toimesta
 Sadece uzman kisiler monte edebilir
 Instalare numai de catre electricieni
 Монтаж может производить только электрик
 Εγκατάσταση μόνο από ηλεκτρολόγους
 仅允许电工安装
 التركيب فقط من قبل عمال كهرباء اخصائيين

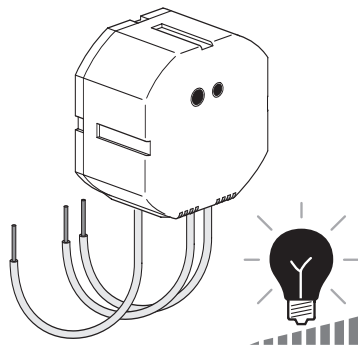

		Min. Version 1.40
		Min. Version 3.5

	T=-25°C - +70°C	IP20
	T=-5°C - +45°C	

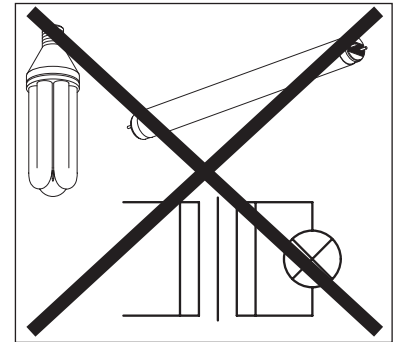

868,3 MHz

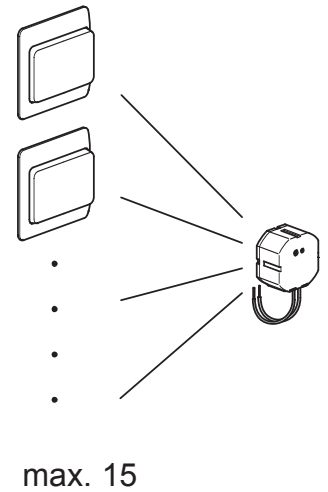
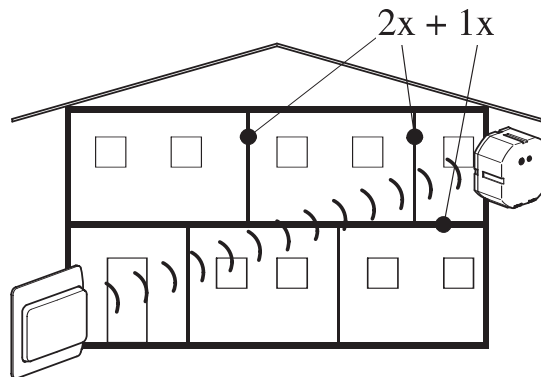
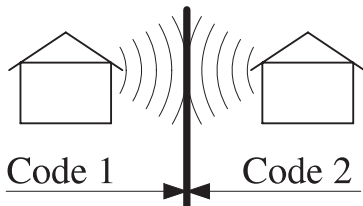
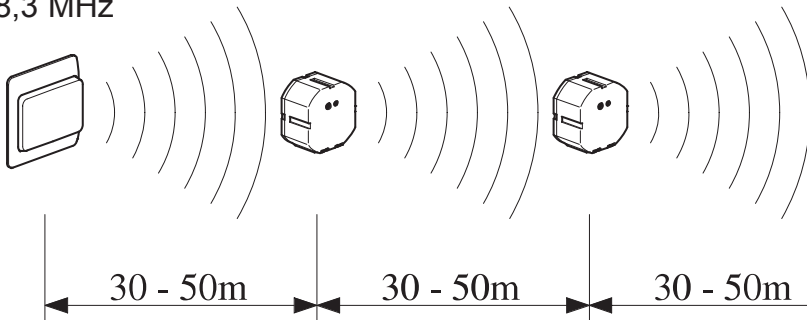

	ca. 60-90%	ca. 80-95%	ca. 20-60%	ca. 0-10%	ca. 70-90%

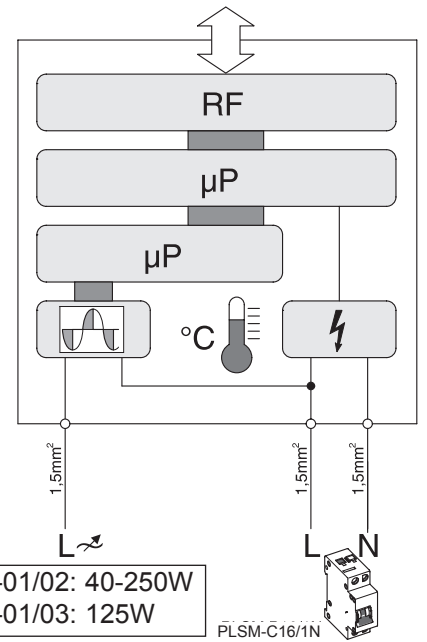
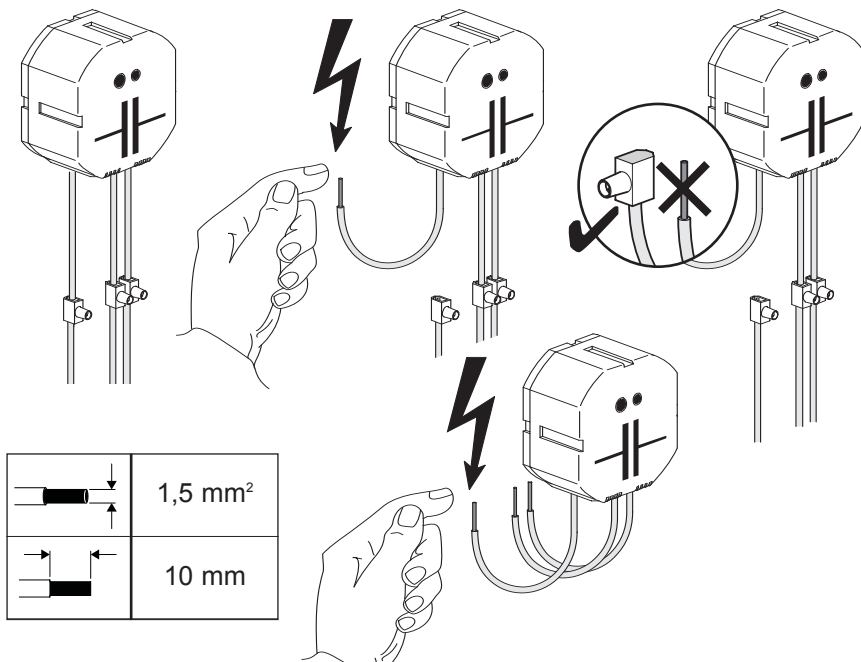

CDAU-01/02

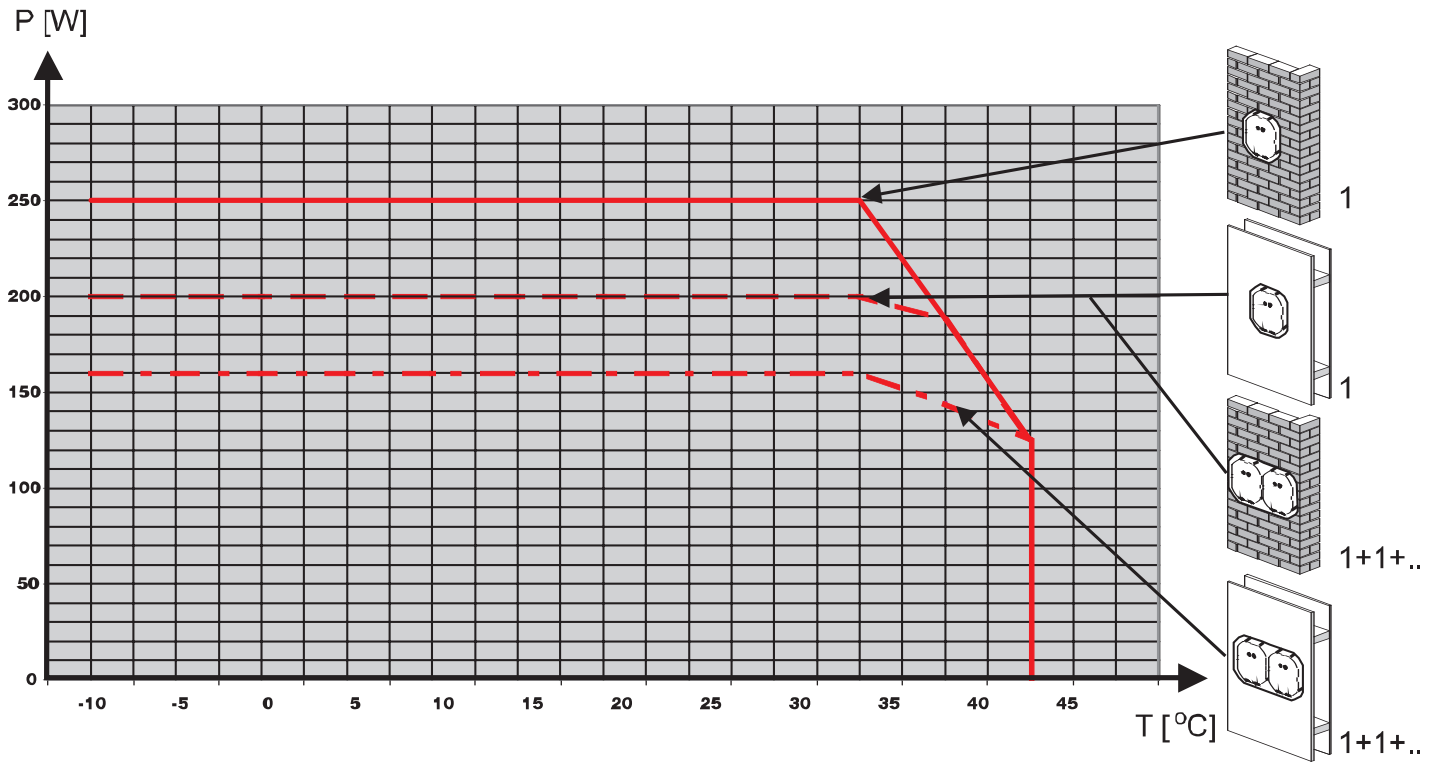

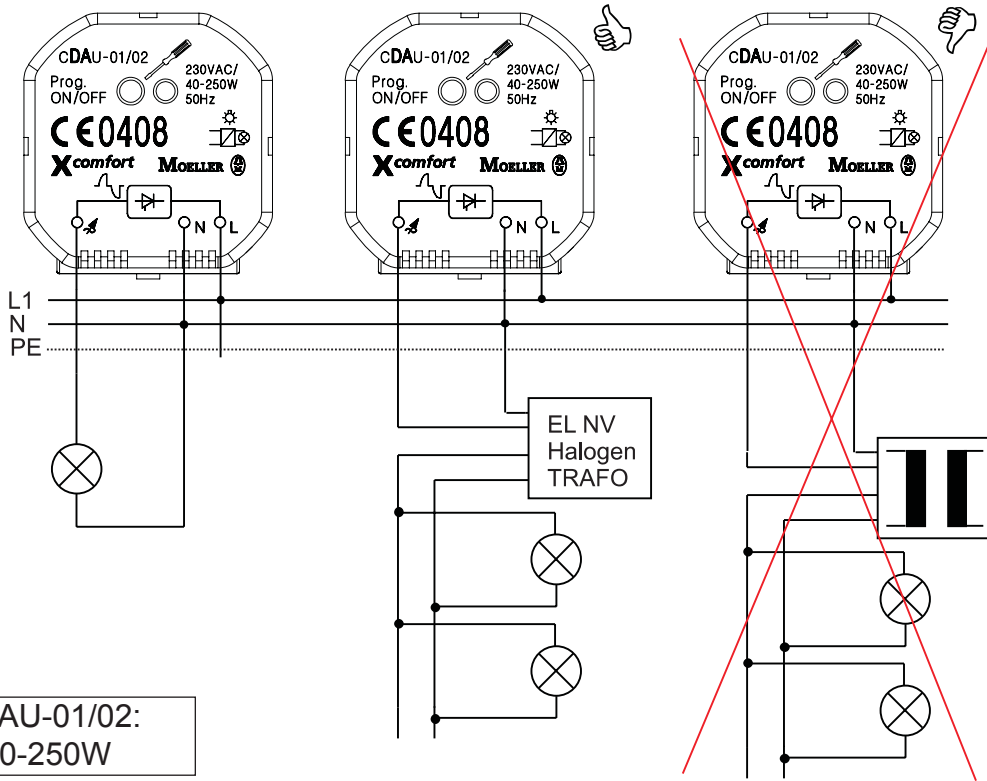

CDAU-01/02:
40-250W

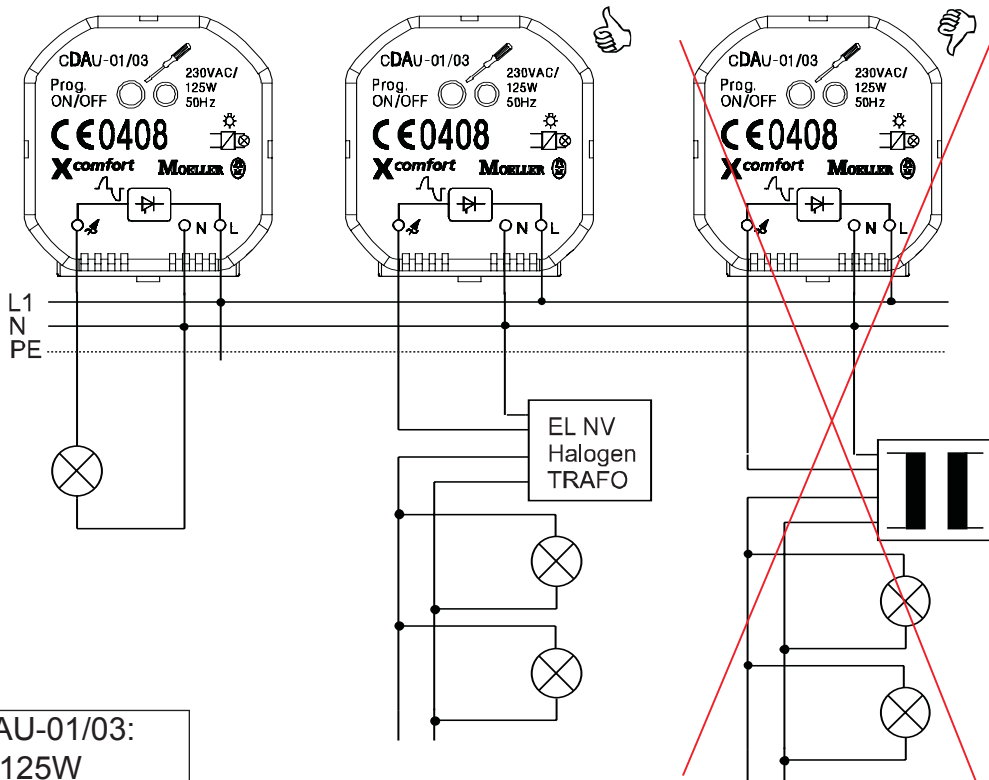

CDAU-01/03:
125W

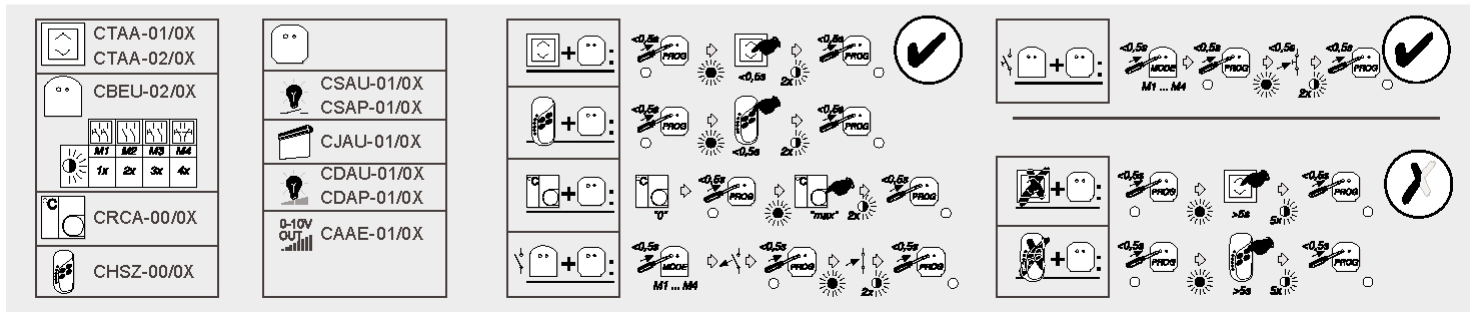
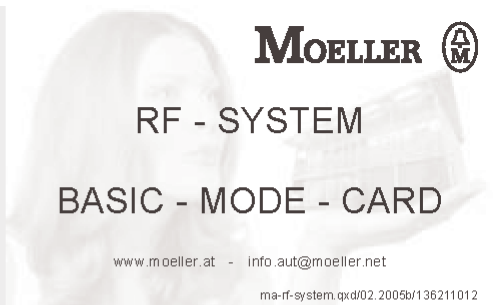
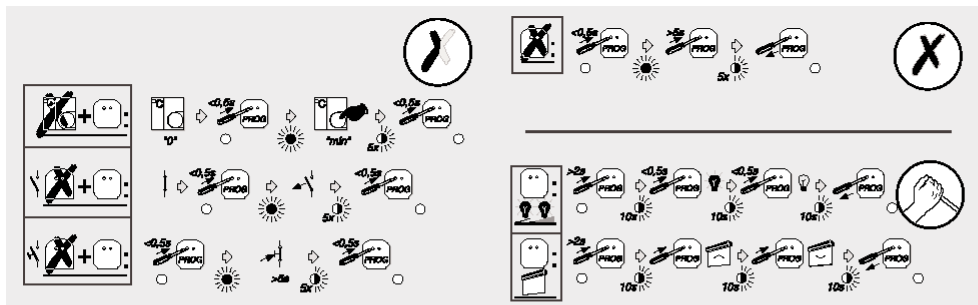

Moeller Gebäudeautomation GmbH

Konformitätserklärung Declaration of Conformity

Wir Moeller Gebäudeautomation GmbH
 We (Name des Anbieters / supplier's name)
 Eugenia 1
 3943 Schrems, Austria
 (Anschrift / adress)

bescheinigen hiermit, dass das Produkt
 hereby certify that the product
 Moeller - Dimmaktor
 Moeller - dimming actuator
 Type: CDAU-01/02, CDAU-01/03
 type-key according actual catalog

auf das sich diese Bescheinigung bezieht, mit der/den folgenden
 Norm(en) oder normativen Dokument(en) übereinstimmt.
 to which this certification relates is in conformity with the following standard(s)
 or other normative document(s).

EN301489-3 V1.4.1; EN50090-2-2/96 + A1/02; EN50428/05, EN55015/00 +
 A1/01 + A2/02; EN61547/95 + A1/00, EN300220-2 V2.1.1, EN300220-2
 V2.1.2, EN50371/02

(Titel und/oder Nr. sowie Ausgabedatum der Norm(en) oder der anderen normativen Dokumente /
 Titel and/or number and date of issue of the standard(s) or other normative document(s).)

Gemäß den Bestimmungen der Richtlinie(n)
 Following the provisions of the Directive(s) falls zutreffend / if applicable

- Niederspannungsrichtlinie 2006 / 95 / EG
 Low Voltage Directive 2006 / 95 / EC
- EMV-Richtlinie 2004 / 108 / EG
 EMC Directive 2004 / 108 / EC
- Radio- und Telekommunikationsendgeräte 99 / 05 / EG
 Radio Equipment and Telecommunications Terminal Equipment 99 / 05 / EC

geprüft von / tested by TÜV Austria Services GmbH, Notified Body 0408
 1230 Wien, Deutschstrasse 1 **CE 0408**
 CTI-Vienna
 1210 Wien, Einzingerasse 4

Konformitätserklärung gemäß ISO/IEC 17050-1
 Declaration of conformity according ISO/IEC 17050-1

Schrems, 20.08.2007
 (Ort, Datum der Ausstellung / place, date of issue)

G. Idinger (G. Idinger) Ing. F. Schöder
 (Name und Unterschrift / name and signature)

Ref: CDAU-01/02, C

